



## CYLINDERS AND PADLOCKS TOKOZ PRO AND TOKOZ TECH

SECURE YOUR WORLD

**PRO** 300

**PRO** 400

**TECH**





# Company Profile



TOKOZ a.s. is a company working in the field of security mechanisms for more than 95 years. Thanks to years of experience we have become real experts on manufacturing of padlocks and today we are the biggest Czech producer in this field.

We have diversified our permanent assortment that includes cylinders, padlocks and other security components such as bars and hasps or building and furniture hardware and added special security mechanisms and accessories.

It is the area of security mechanisms that we have focused on the most in recent years, and with our motto

## **“SECURE YOUR WORLD”**

it is your own world we help to secure!

The products you can find in our current offer involve not only the time-proven and in some fields still irreplaceable TOKOZ products, but also new mechanisms that comply with present-day requirements and provide specific solutions.

**WITH EVERY STEP WE MAKE, WE WANT TO KEEP CONTRIBUTING TO OUR GOOD REPUTATION OF A STRONG CZECH MANUFACTURER OF LOCKS AND FITTINGS**

# Products



## TOKOZ PRO AND TOKOZ TECH PRODUCTS ARE SUITABLE FOR SECURITY OF:

FAMILY HOUSES ▪ FLATS, BLOCKS OF FLATS, OTHER AREAS (BASEMENT, BICYCLE ROOMS) ▪ COMPANIES (OUTSIDE AND INSIDE DOORS, E. G. OFFICE DOORS) ▪ INSTITUTIONS ▪ HOTELS ▪ EXHIBITION GROUNDS, MUSEUMS ▪ SCHOOLS ▪ PUBLIC BUILDINGS ▪ HOSPITALS ▪ SHOPPING CENTRES ▪ SPORTS HALLS ▪ VARIOUS COMPOUNDS (WATERWORKS, FORESTRY COMPOUNDS, NATIONAL AND ARMY PREMISES, ETC.)

**TOKOZ a.s.** is a company that provides their customers with products which meet the latest technical and consumer requirements. Our aim is to produce products of the highest quality that fulfill requirements necessary to be approved as **security class** no. 3 and 4 in accordance with the European standards. The security classes determine not only the resistance to various methods of breaking but also the lifespan, which is the period of time when the product is bound to maintain its quality and reliability even when exposed to high stress.

Unification of locking mechanism of our products, integration into various keyed systems and

interconnection with cylinders were the reasons for our decision to start producing cylinders.

During the development and manufacturing processes we used our experience and technical base acquired from years of making padlocks and other security mechanisms.

Products from the **TOKOZ PRO** and **TOKOZ TECH** ranges are therefore suitable for exterior areas showing **high resistance to destructive and non-destructive methods** of breaking and to extreme climatic conditions, as well as interior areas with major emphasis on the lifespan of the cylinder used on daily basis.



# How to buy the right cylinder?

The TOKOZ PRO cylinders are especially suitable for securing the front door of family houses, flats, blocks of flats and other main entrances.

Not only they are extremely resistant to various methods of breaking but above all they are developed in such a way so that they can tolerate diverse outside conditions.

## We offer cylinders in the following variations:

- » Double cylinder
- » Double cylinder with thumbturn
- » Double cylinder with sprocket
- » Single cylinder

It is necessary to fit a cylinder in the door exactly according to our instructions, otherwise we cannot guarantee the security and correct operation of the cylinder.

It is essential to determine the size of a cylinder according to the thickness of a door with hardware. It is always measured from the centre of the fastening bolt to the outer edges of the fittings in both directions.

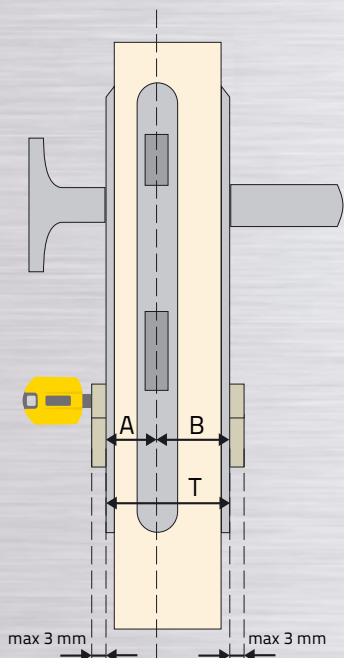

Note: more details on how to order can be found in the price list.

Required size of a cylinder is obtained by combining the numbers, e. g. 35+45 (TOKOZ PRO 300 35/45). The size of a cylinder must be the same or bigger than thickness of the door with hardware. It must not exceed the shield of fitting by more than 3 mm – safety reasons.

The products are marked with a class and pictograms of use.

## Security class

All products are categorized into classes according to their breaking and devaluation resistance. Classes are indicated on all certified products to make the product selection easier.

WE HAVE MADE A CERTIFICATION CHART ACCORDING TO EUROPEAN STANDARDS.

Product	European standard	SECURITY CLASS					
		1	2	3	4	5	
Padlocks	EN 12320	Class 1	Class 2	Class 3	Class 4	Class 5	
Cylinders	EN 1303	key	Class 4	Class 4	Class 4	Class 6	-
		breaking	Class 1	Class 1	Class 1	Class 2	-
Fillings (doors etc.)	EN 1627	Class 1	Class 2	Class 3	Class 4	-	



## SAFE COUNTRY PROJECT

Our company is part of the SAFE COUNTRY PROJECT. The purpose of this project is criminality prevention and protection of property and people in our country. The places of business as well as the products of the association may use the Safe country marking. Our company engages in active cooperation with other members and partners of the project.

## Partners of the project



Ministry of the interior of the Czech Republic



Chamber of Commerce



Police of the Czech Republic



Mechanical Lock Systems Association

# Certificates



Outstanding quality of TOKOZ products is also proved by product certificates from independent accredited testing laboratories.

We use the following accredited testing laboratories to certify our products:

- » SZU Engineering Test Institute, Brno, Czech Republic
- » TREZOR TEST s.r.o., Klecany, Czech Republic
- » REVIMONT-DG s.r.o., Slovakia
- » SKG-IKOB CERTIFICATIE, Netherlands

Our products certify primarily according to these three standards:

EN 1303 – European standard that contains regulations over function properties of cylinders and their original keys including other requirements on resistance, burglary protection, lifespan and corrosion resistance. The standard establishes one application category according to function properties and three security classes as per tests that simulate a mechanical attack (six security classes related to the risk of unlocking with the wrong key).

EN 1630 in response EN 1627 in accordance with the requirements for the locking system of the type – defines product resistance to drilling, lock picking, pull out, bumping, brute force, etc.

EN 12320 – specifies requirements and describes testing methods for strength, security, functionality and corrosion resistance in padlocks and their accessories.

TOKOZ products are mainly intended for external use since they withstand extreme climatic condition over a long period of time. In support of our claim is also the fact that our products undergo tests in a salt-spray cabinet and exceed the standards for given products several fold. Detailed information on resistance is given with each product. Products are also tested in dusty environment, water and freezing temperatures.

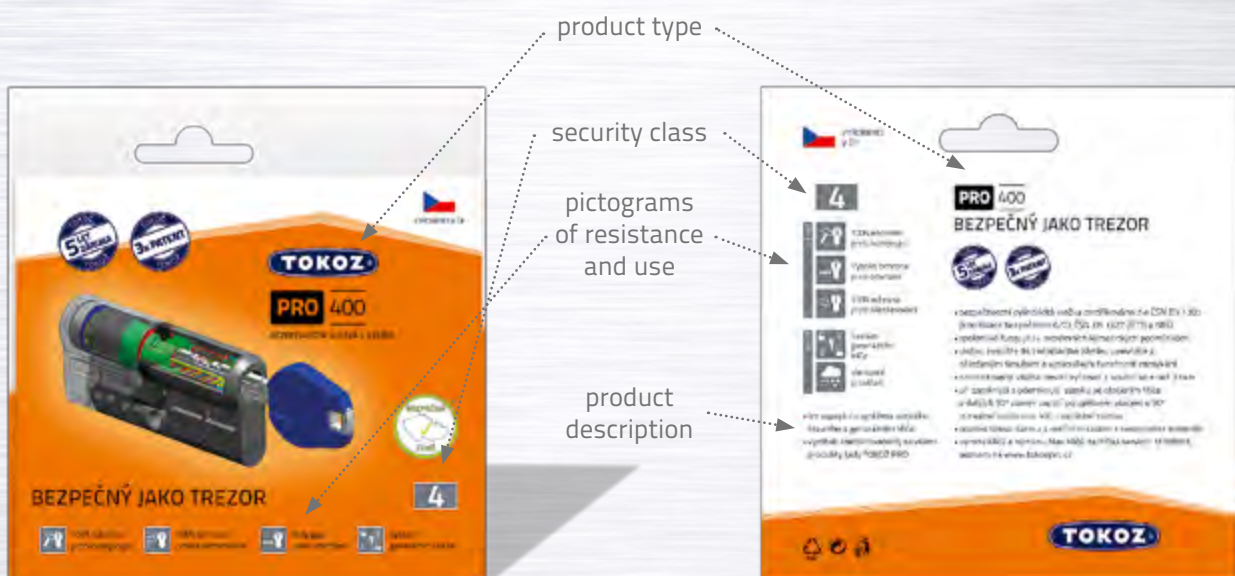

For bulk orders, the packaging can be adapted according to customer's wish.



# Keyed systems

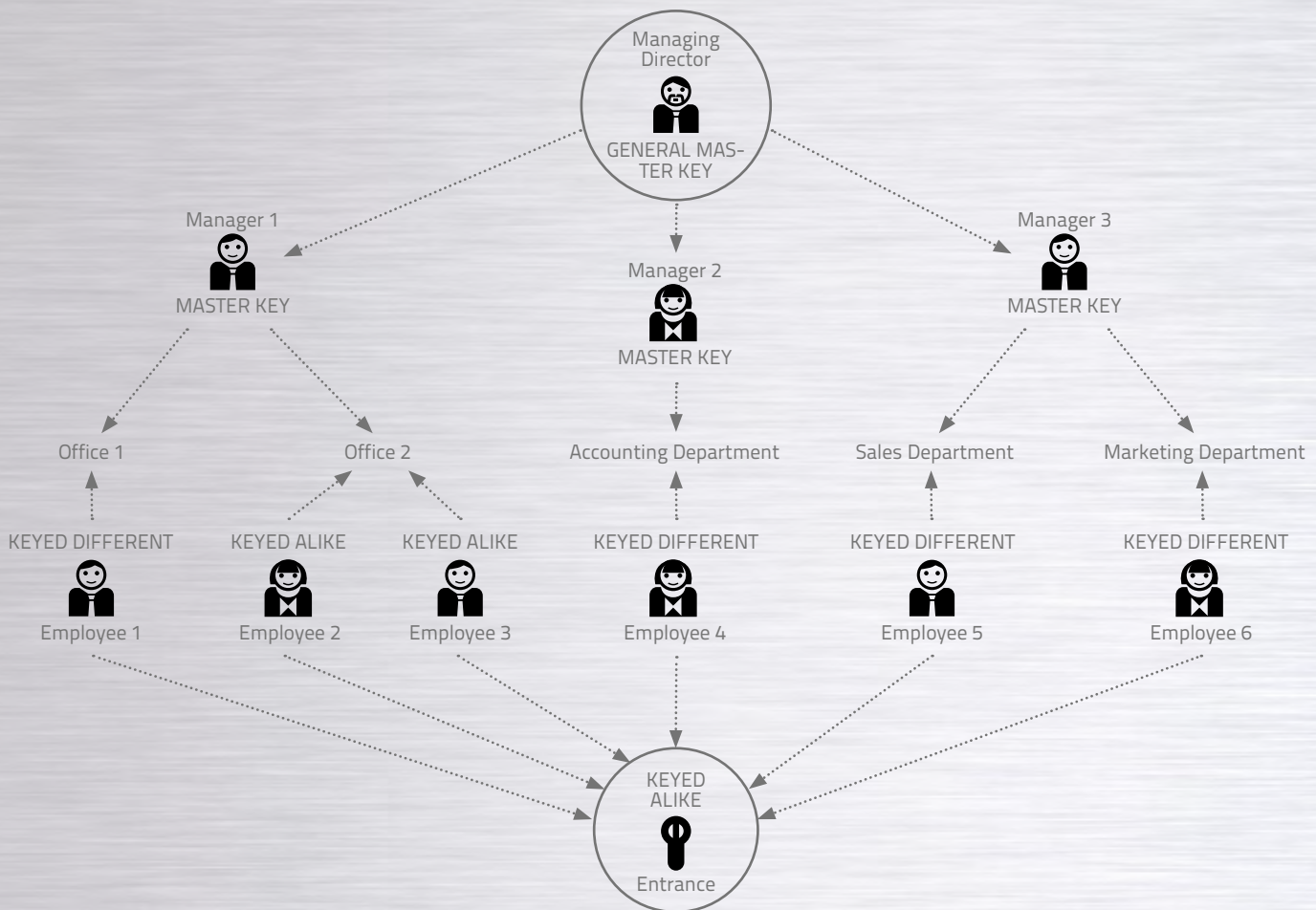

The purpose of locking systems is to create a functional system of superior and ordinary keys according to access rights, and thereby reduce the overall number of keys carried by individuals to a minimum.

## Keyed Different system

Every lock has its proper key that cannot operate other locks.

## Keyed Alike system

More than one lock can be opened with the same key.



## Master Keyed system

All locks are keyed to a specific key that unlocks only the relevant lock. A relevant group of locks can be then opened with a Master key according to the access rights (e. g. employees have their own keys and their boss has a Master key that can unlock his/her own office and also offices of the employees but it will not unlock offices in other sectors).

## General Master Keyed system

One key operates all locks in the company. It is superior to Master keys. It is intended for the use of the owner of the company, security agency and fire brigade. It can also be placed within the company premises in a sealed safety box for emergency cases.



# System TOKOZ PROfessional

## SECURE AS A SAFE BOX – SAFE-LIKE LOCKS AND KEYS



### CYLINDER CONSTRUCTION FOR TOKOZ PRO SYSTEM IS PROTECTED BY THREE PATENTS.

Patent CZ 303 062

Patent CZ 302 949

Patent CZ 303 063

### TOKOZ A.S. PROVIDES A 5-YEAR GUARANTEE ON TOKOZ PRO PRODUCTS.

**TOKOZ PRO** cylinder represents **maximum security** amongst cylinders. This new locking system is particularly resistant to so called non-destructive methods of breaking such as picking, bumping, etc. The key alignment that is made of hardened steel rotates if there is an attempt to drill it off. These attributes and **the resistance to wrenching of the inner mechanism** put this type of a cylinder and other products featuring the TOKOZ PRO locking system in **the highest security level**.

The base of the **TOKOZ PRO** locking system consists of a row of rotary discs rotating in special that create the very basis of the cylinder rotor. **This new patented system** is operated by a symmetrical key that can be turned only once it is completely inserted into the cylinder, which prevents from damaging the cylinder by unauthorized or unqualified manipulation. The key cuts carry the rotary discs that create the combination code of the cylinder. The discs are moved by the key in both directions. There is no need for springs to return them to the original position. This basic advantage allows easy usage of the locking mechanism even in extreme climatic conditions such as water, humidity, snow, freezing temperatures, dust, etc. and entails low wear of the inner parts, and consequently the overall lifespan, and reliability of the cylinder that shows no operating problems in the locking mechanism even after hundreds of thousands occasions of locking and unlocking. It is therefore suitable for frequent application. The cylinder is not ready to be unlocked when the key is inserted, which only proves the uniqueness of the construction in comparison with other types of lock cylinders. The discs do not align at that point and so **the cylinder cannot be picked**.

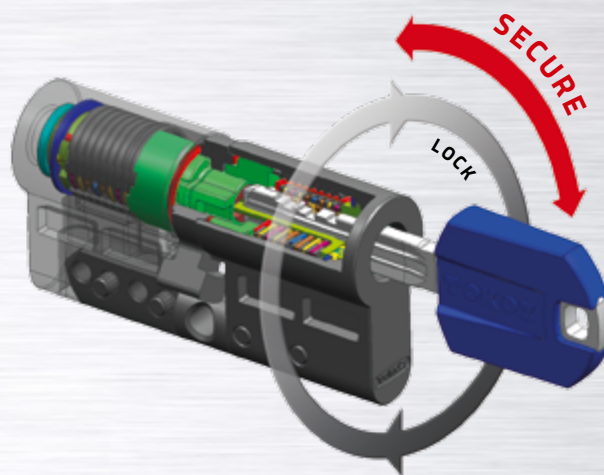

In order to place the discs into locking position, it is necessary to turn the key by 90°. It is only by further application of the torque that the cylinder unlocks. It is a case of securing the locking mechanism. It represents a fundamental and competitive advantage that places the **TOKOZ PRO** cylinder at the top of the resistance scale as for non-destructive methods of breaking locks which have recently spread considerably.

Combinatorics of the locking system can be increased with individual key profiles that are also patented. It ensures a high number of locking combinations, which consequently brings non-recurring key combinations.

Colour coding of individual key groups can help to distinguish individual levels of master keyed systems. Another benefit of the **TOKOZ PRO** cylinders is their high passive key protection, which means that duplicate keys can be made only with a security card that is provided with cylinders as standard.

Resistance	4	Security class	Application		Master keyed system
	3	Security class			Outdoor conditions
		100% bumping resistance (anti-bump)			
		Maximum protection against drilling (anti-drill)			
		100% protection against lock picking (anti-pick)			
		Protection against snapping			



# TOKOZ PRO Cylinder



## Revolution in locking

**TOKOZ PRO** cylinders belong among the best locking systems on the Czech market as well as world market. They are suitable for both demanding daily use and places with stress on greater security such as main entrances of houses, flats and companies.

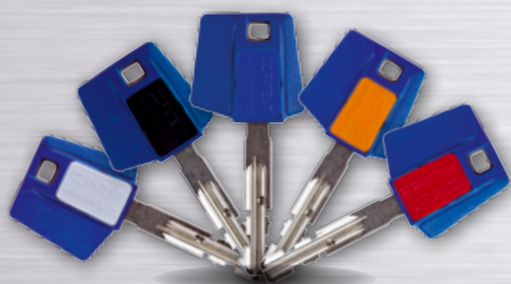
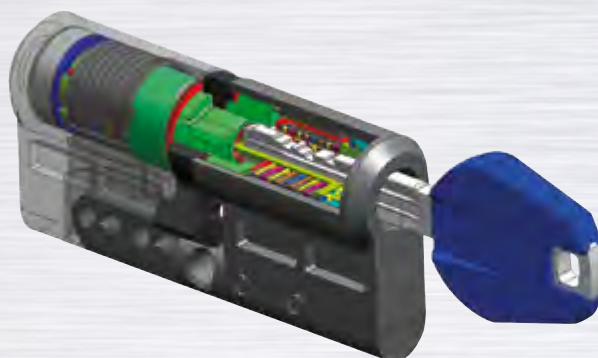



# TOKOZ PRO



- > a security lock cylinder certified in compliance with EN 1303, EN 1627
- > a mechanism locked via rotating discs
- > 100% resistance to lock picking and lock bumping
- > maximum protection against drilling
- > reliable even in extreme climatic conditions such as dust, freezing temperatures, water, grease
- > components of the locking mechanism made of stainless material
- > modular construction – easy assembly of various lengths
- > offers the possibility of the Keyed Alike systems (KA marking) integrated with TOKOZ PRO products
- > offers the possibility to use the Master Keyed and General Master Keyed (SGMK marking) systems with TOKOZ PRO products
- > compatible with all types of standard hardware
- > suitable for standard and atypical door thickness
- > surface finishing: Satin-nickel body
- > Key selection option
  - symmetrical machine-cut keys with replaceable plastic bow in blue, orange, black, grey, and red colour
  - asymmetrical machine-cut keys with plastic bow and colour cap in blue, orange, black, grey, and red colour
  - asymmetrical all-metal keys
- > easy key manipulation in the dark
- > legal protection against plagiarism ensured by patent
- > standardly supplied with five keys and a security card that prevents from key duplication
- > box packaging

TOKOZ PRO SYSTEM IS PATENT-PROTECTED.



For bulk orders, the packaging can be adapted according to customer's wish.



DOUBLE  
CYLINDER



Item	Purchase Order number	Purchase Order number – product with emergency function	Cylinder size	Total length
TOKOZ PRO 400 33/33	7540001	27201	33/33	66
TOKOZ PRO 400 33/38	7540003	27203	33/38	71
TOKOZ PRO 400 33/43	7540007	27207	33/43	76
TOKOZ PRO 400 33/48	7540013	27213	33/48	81
TOKOZ PRO 400 33/53	7540015	27215	33/53	86
TOKOZ PRO 400 33/58	7540019	27219	33/58	91
TOKOZ PRO 400 38/38	7540005	27205	38/38	76
TOKOZ PRO 400 38/43	7540009	27209	38/43	81
TOKOZ PRO 400 38/48	7540011	27211	38/48	86
TOKOZ PRO 400 38/53	7540021	27221	38/53	91
TOKOZ PRO 400 38/58	7540025	27225	38/58	96
TOKOZ PRO 400 43/43	7540017	27217	43/43	86
TOKOZ PRO 400 43/48	7540023	27223	43/48	91
TOKOZ PRO 400 43/53	7540027	27227	43/53	96
TOKOZ PRO 400 43/58	7540031	27231	43/58	101
TOKOZ PRO 400 48/48	7540029	27229	48/48	96
TOKOZ PRO 400 48/53	7540033	27233	48/53	101



DOUBLE  
CYLINDER WITH THUMBTURN



Item	Purchase Order number	Cylinder size	Total length
TOKOZ PRO 400 with thumbturn 33/30	7650001	33/30	63
TOKOZ PRO 400 with thumbturn 33/35	7650002	33/35	68
TOKOZ PRO 400 with thumbturn 33/40	7650003	33/40	73
TOKOZ PRO 400 with thumbturn 33/45	7650004	33/45	78
TOKOZ PRO 400 with thumbturn 33/50	7650005	33/50	83
TOKOZ PRO 400 with thumbturn 33/55	7650006	33/55	88
TOKOZ PRO 400 with thumbturn 38/35	7650008	38/35	73
TOKOZ PRO 400 with thumbturn 38/40	7650009	38/40	78
TOKOZ PRO 400 with thumbturn 38/45	7650010	38/45	83
TOKOZ PRO 400 with thumbturn 38/50	7650011	38/50	88
TOKOZ PRO 400 with thumbturn 38/55	7650012	38/55	93
TOKOZ PRO 400 with thumbturn 43/40	7650015	43/40	83
TOKOZ PRO 400 with thumbturn 43/45	7650016	43/45	88
TOKOZ PRO 400 with thumbturn 43/50	7650017	43/50	93
TOKOZ PRO 400 with thumbturn 43/55	7650018	43/55	98
TOKOZ PRO 400 with thumbturn 48/45	7650022	48/45	93
TOKOZ PRO 400 with thumbturn 48/50	7650023	48/50	98

**Cylinder with thumbturn** – when ordering a thumbturn product, it is necessary to indicate with a letter "K" the cylinder side with thumbturn (e. g. TOKOZ PRO 400 30/K35).



Item	Purchase Order number	Cylinder size	Total length
TOKOZ PRO 400 with sprocket 33/33	26401	33/33	66
TOKOZ PRO 400 with sprocket 33/38	26403	33/38	71
TOKOZ PRO 400 with sprocket 33/43	26407	33/43	76
TOKOZ PRO 400 with sprocket 33/48	26413	33/48	81
TOKOZ PRO 400 with sprocket 33/53	26415	33/53	86
TOKOZ PRO 400 with sprocket 33/58	26419	33/58	91
TOKOZ PRO 400 with sprocket 38/38	26405	38/38	76
TOKOZ PRO 400 with sprocket 38/43	26409	38/43	81
TOKOZ PRO 400 with sprocket 38/48	26411	38/48	86
TOKOZ PRO 400 with sprocket 38/53	26421	38/53	91
TOKOZ PRO 400 with sprocket 38/58	26425	38/58	96
TOKOZ PRO 400 with sprocket 43/43	26417	43/43	86
TOKOZ PRO 400 with sprocket 43/48	26423	43/48	91
TOKOZ PRO 400 with sprocket 43/53	26427	43/53	96
TOKOZ PRO 400 with sprocket 43/58	26431	43/58	101
TOKOZ PRO 400 with sprocket 48/48	26429	48/48	96
TOKOZ PRO 400 with sprocket 48/53	26433	48/53	101



DOUBLE CYLINDER WITH SPROCKET (10 TEETH)



Item	Purchase Order number	Cylinder size	Total length
Single cylinder TOKOZ PRO 400 33	7610001	33	33
Single cylinder TOKOZ PRO 400 38	7610002	38	38



SINGLE CYLINDER



## ATTENTION NEW ITEM!

**Emergency function** – this function enables cylinder to be opened even in case of key being inserted from the other side. TOKOZ PRO products emergency function is unilateral and its correct door orientation is labeled with "OUT" and an arrow.



Prostupová spojka  
Emergency function  
PACKAGE LABELING

**Adjustable cam** – starting 2016, this function is a standard in all TOKOZ PRO cylinders. It enables cam setting into one of twelve possible positions, each by 30°. Cam setting is done in manufacturing or by your locksmith. Standard setting is 30°.



Stavitelný zub  
Adjustable cam  
PACKAGE LABELING



DOUBLE  
CYLINDER



Item	Purchase Order number	Purchase Order number – product with emergency function	Cylinder size	Total length
TOKOZ PRO 300 30/30	7390001	27001	30/30	60
TOKOZ PRO 300 30/35	7390003	27003	30/35	65
TOKOZ PRO 300 30/40	7390007	27007	30/40	70
TOKOZ PRO 300 30/45	7390013	27013	30/45	75
TOKOZ PRO 300 30/50	7390015	27015	30/50	80
TOKOZ PRO 300 30/55	7390019	27019	30/55	85
TOKOZ PRO 300 35/35	7390005	27005	35/35	70
TOKOZ PRO 300 35/40	7390009	27009	35/40	75
TOKOZ PRO 300 35/45	7390011	27011	35/45	80
TOKOZ PRO 300 35/50	7390021	27021	35/50	85
TOKOZ PRO 300 35/55	7390025	27025	35/55	90
TOKOZ PRO 300 40/40	7390017	27017	40/40	80
TOKOZ PRO 300 40/45	7390023	27023	40/45	85
TOKOZ PRO 300 40/50	7390027	27027	40/50	90
TOKOZ PRO 300 40/55	7390031	27031	40/55	95
TOKOZ PRO 300 45/45	7390029	27029	45/45	90
TOKOZ PRO 300 45/50	7390033	27033	45/50	95



DOUBLE  
CYLINDER WITH THUMBTURN



Item	Purchase Order number	Cylinder size	Total length
TOKOZ PRO 300 with thumbturn 30/30	76401	30/30	60
TOKOZ PRO 300 with thumbturn 30/35	76402	30/35	65
TOKOZ PRO 300 with thumbturn 30/40	76403	30/40	70
TOKOZ PRO 300 with thumbturn 30/45	76404	30/45	75
TOKOZ PRO 300 with thumbturn 30/50	76405	30/50	80
TOKOZ PRO 300 with thumbturn 30/55	76406	30/55	85
TOKOZ PRO 300 with thumbturn 35/35	76408	35/35	70
TOKOZ PRO 300 with thumbturn 35/40	76409	35/40	75
TOKOZ PRO 300 with thumbturn 35/45	76410	35/45	80
TOKOZ PRO 300 with thumbturn 35/50	76411	35/50	85
TOKOZ PRO 300 with thumbturn 35/55	76412	35/55	90
TOKOZ PRO 300 with thumbturn 40/40	76415	40/40	80
TOKOZ PRO 300 with thumbturn 40/45	76416	40/45	85
TOKOZ PRO 300 with thumbturn 40/50	76417	40/50	90
TOKOZ PRO 300 with thumbturn 40/55	76418	40/55	95
TOKOZ PRO 300 with thumbturn 45/45	76422	45/45	90
TOKOZ PRO 300 with thumbturn 45/50	76423	45/50	95

**Cylinder with thumbturn** – when ordering a thumbturn product, it is necessary to indicate with a letter "K" the cylinder side with thumbturn (e. g. TOKOZ PRO 300 30/K35).



Item	Purchase Order number	Cylinder size	Total length
TOKOZ PRO 300 with sprocket 30/30	26201	30/30	60
TOKOZ PRO 300 with sprocket 30/35	26202	30/35	65
TOKOZ PRO 300 with sprocket 30/40	26203	30/40	70
TOKOZ PRO 300 with sprocket 30/45	26204	30/45	75
TOKOZ PRO 300 with sprocket 30/50	26205	30/50	80
TOKOZ PRO 300 with sprocket 30/55	26206	30/55	85
TOKOZ PRO 300 with sprocket 35/35	26208	35/35	70
TOKOZ PRO 300 with sprocket 35/40	26209	35/40	75
TOKOZ PRO 300 with sprocket 35/45	26210	35/45	80
TOKOZ PRO 300 with sprocket 35/50	26211	35/50	85
TOKOZ PRO 300 with sprocket 35/55	26212	35/55	90
TOKOZ PRO 300 with sprocket 40/40	26215	40/40	80
TOKOZ PRO 300 with sprocket 40/45	26216	40/45	85
TOKOZ PRO 300 with sprocket 40/50	26217	40/50	90
TOKOZ PRO 300 with sprocket 40/55	26218	40/55	95
TOKOZ PRO 300 with sprocket 45/45	26222	45/45	90
TOKOZ PRO 300 with sprocket 45/50	26223	45/50	95



DOUBLE CYLINDER  
WITH SPROCKET  
(10 TEETH)



Item	Purchase Order number	Cylinder size	Total length
Single cylinder TOKOZ PRO 300 30	76001	30	30
Single cylinder TOKOZ PRO 300 35	76002	35	35



SINGLE  
CYLINDER



## ATTENTION NEW ITEM!

**Emergency function** – this function enables cylinder to be opened even in case of key being inserted from the other side. TOKOZ PRO products emergency function is unilateral and its correct door orientation is labeled with "OUT" and an arrow.



Prostupová spojka  
Emergency function  
PACKAGE LABELING

**Adjustable cam** – starting 2016, this function is a standard in all TOKOZ PRO cylinders. It enables cam setting into one of twelve possible positions, each by 30°. Cam setting is done in manufacturing or by your locksmith. Standard setting is 30°.



Stavitelný zub  
Adjustable cam  
PACKAGE LABELING

# TOKOZ PRO with a thumbturn and a safety catch

## TOKOZ PRO with a thumbturn and a safety catch against accidental door opening

The cylinder with a thumbturn knob and a safety catch is locked and unlocked just like any other lock of such type. The feature that adds an extra function is the securing bolt. Pulling the thumbturn knob until the securing bolt springs out from the slot in the thumbturn knob puts out of operation the part of the locking mechanism that is controlled by a key, which makes unlocking the door with a key impossible from outside.

In order to restore the key function, it is necessary to position the thumbturn knob vertically so that the securing bolt is pointed upwards and then push the bolt into the knob. The function is particularly useful against unwanted opening from the outside, for example at night.



Steel

Silver

Bronze

Black

We also offer the lock with a thumbturn in a variant without the safety catch.

You may choose the colour of the thumbturn from several variants offered.

**ATTENTION!** Cylinders with thumbturn are generally not suitable for forging in and glass doors – security reasons.

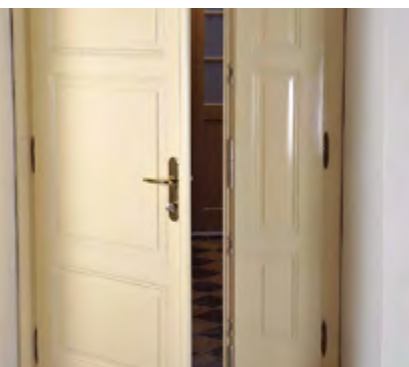



# Konti PRO

## Securing containers and dustbins

KONTI PRO container lock can be integrated into the TOKOZ PRO system. Innovation of the current version of the KONTI lock brings increased security and possibility to connect to the standard Master Keyed and General Master Keyed systems. The lock can be used for both securing containers and dustbins, and as **anchor system for free-standing objects** or an additional lock for attic and basement areas.



23411

### KONTI PRO 9



- > provided with TOKOZ PRO safety locking system
- > offers the possibility of the Keyed Alike systems (KA marking) integrated with TOKOZ PRO products
- > offers the possibility to use the Master Keyed and General Master Keyed (SGMK marking) systems with TOKOZ PRO products
- > cylinder with high protection against drilling and 100% protection against lock picking and lock bump



23401

### KONTI PRO 12



- > reliable in extreme climatic conditions
- > lock body made of zinc alloy is more resistant to forced attack
- > steel chain extremely resistant to wrenching, 9 or 12 chain links (adjustable according to requirements of the customer)
- > surface finishing: varnished body, galvanized chain
- > supplied with fasteners

	KONTI PRO 9	KONTI PRO 12
Quantity of the keys	2	2
Package of 1 piece/bulk	without package or skin/box	without package or skin/box
Number of pieces in a bulk package	10	10
Weight of bulk package in kg	8,9	9,1



# GAMA – Padlock



## GAMA

Evolution is taking place in padlocks production, too, and the Gama padlocks are currently at its top. Padlocks with TOKOZ PRO locking system are suitable for individual use in extreme environments but they are especially suited to Keyed systems with door cylinders and other locking mechanisms.

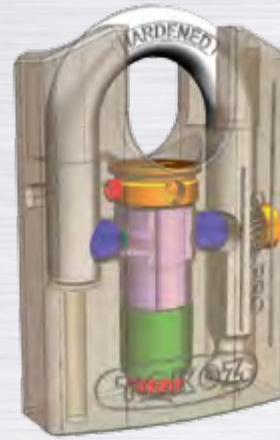

**52861**  
GAMA 70 CS Silver



**NEW PRODUCT**

- > certified in compliance with EN 1627, EN 12320
- > provided with TOKOZ PRO 400 or TOKOZ PRO 300 security locking system
- > cylinder with high protection against drilling and 100% protection against lock picking and lock bumping
- > components of the locking mechanism made of stainless material
- > reliable even in extreme climatic conditions (water, freezing temperatures, dust, grease)
- > offers the possibility of the Keyed Alike systems (KA marking) integrated with TOKOZ PRO products
- > offers the possibility to use the Master Keyed and General Master Keyed (SGMK marking) systems with TOKOZ PRO products
- > GAMA 70 and 60 has a hardened-steel body resistant to forced attack, drilling and breaking
- > GAMA 50 has a solid zinc body resistant to forced attack and breaking

- > surface finishing in silver or black colour
- > hardened shackle with improved resistance to cutting, sawing, prying and hammering
- > both-side-secured shackle revolves by 360° after unlocking
- > CS (Cover Shackle) – a covered shackle for enhanced protection against sawing and cutting
- > OS (Open Shackle) – an open shackle for easier manipulation in less accessible places
- > RC (Remove Shackle) – remove shackle for easier manipulation in less accessible places
- > the key can only be pushed in and pulled out when the padlock is locked
- > safe-like light symmetrical keys with exchangeable bow (different colour options: blue, orange, black, grey and red)
- > GAMA 70 RC – silver colour
- > GAMA 40 – only in OS version and silver colour

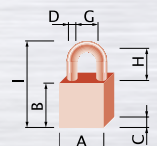



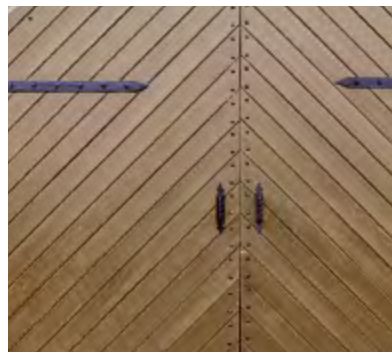
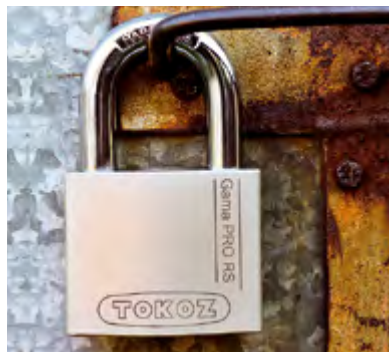

52841

GAMA 60 CS Silver



52832  
GAMA 60 OS Black



52941

GAMA 50 CS Silver



52932  
GAMA 50 OS Black



52831  
GAMA 60 OS Silver



52842  
GAMA 60 CS Black



52931  
GAMA 50 OS Silver



52942  
GAMA 50 CS Black



	GAMA 70 CS	GAMA 70 OS	GAMA 70 RS	GAMA 60 CS	GAMA 60 OS	GAMA 50 CS	GAMA 50 OS	GAMA 40
Dimension A	72	72	72	62	62	52	52	44
Dimension B	60	60	60	58	58	80	52	49
Dimension C	30	30	30	28	28	26	26	24
Dimension D	14	14	14	12	12	10	10	8
Dimension G	33	33	33	29	29	22	25	23
Dimension H	26	26	42	24	24	22	22	22
Dimension I	100	100	116	94	94	84	84	79
Steel Body	x	x	x	x	x			
Zink Body						x	x	x
Hardened shackle	x	x	x	x	x	x	x	x
Number of keys	3	3	3	3	3	3	3	3
Identification Card	x	x	x	x	x	x	x	x
Packaging	coloured box	coloured box	blistr	coloured box	coloured box	coloured box	coloured box	open plastic box
Quantity per package	1	1	1	1	1	1	1	1
Weight in kg	1,02	0,99	1,02	0,75	0,73	0,50	0,49	0,34

52910

GAMA 40 OS Silver



**NEW PRODUCT**



# EXTREME PRO – Padlock

## EXTREME PRO

The padlock is a classic TOKOZ design with heightened security. The padlock offers a removable shackle and completes the TOKOZ PRO product range. The EXTREME PRO padlock is a great choice particularly for places with limited possibility of movement where it is more convenient to handle the body and the shackle separately. It is also applicable in places where the padlock body requires a rubber case.



EXTREME PRO						
Dimension A	Dimension B	Dimension C	Dimension D	Dimension G	Dimension H	Dimension I
58	38,7	41,5	9	21,5	31	80,4
Steel cup	Hardened shackle	Number of keys	Identification Card	Package of 1 piece/bulk coloured box	Quantity per package	Weight of bulk package in kg



### 52501 EXTREME PRO



- > certified in compliance with EN 12320, EN 1627
- > provided with the TOKOZ PRO 300 safety locking system
- > cylinder lock offers high protection against drilling and 100% protection against lock picking and lock bumping
- > components of the locking mechanism are made of stainless material
- > reliable in extreme climatic conditions
- > offers the possibility of the Keyed Alike systems (KA marking) integrated with TOKOZ PRO products
- > offers the possibility to use the Master Keyed and General Master Keyed (SGMK marking) systems with TOKOZ PRO products
- > the body made of a steel cup withstands forced attack and the hardened bottom part is protected against drilling
- > hardened shackle with improved resistance to snatching and cutting

- > maximum resistance to snatching the shackle is ensured by a system of pin bolts
- > removable shackle makes manipulation in less accessible places easier
- > impact protection of locked objects by rubber cover on the body of the padlock
- > the key can only be pushed in and pulled out when the padlock is locked
- > keys with exchangeable bow (different colour options: blue, orange, black, grey and red)
- > standardly supplied with three keys and a security card that prevents from key duplication
- > recommended to use with TOKOZ hasps or chains

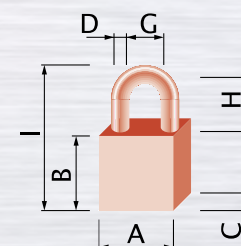



# Cam Lock TOKOZ PRO

## Securing of switchboards and cabinets

Cam Lock PRO may be implemented into the TOKOZ PRO locking system bringing further options in the use of standard Keyed Alike and Master Keyed systems. The lock is intended mainly for switchboard cabinets, but it will safely secure any type of box.



57203

### CAM LOCK PRO



- > provided with TOKOZ PRO safety locking system
- > offers the possibility of the Keyed Alike systems (KA marking) integrated with TOKOZ PRO products
- > offers the possibility to use the Master Keyed and General Master Keyed (SGMK marking) systems with TOKOZ PRO products
- > cylinder with high protection against drilling and 100% protection against lock picking and lock bumping
- > reliable in extreme climatic conditions
- > product is certified according with EN 1303 RC related key 6
- > designed to lock lockers, switchboard cabinets, etc.
- > single position lock
- > 2 types of cam in packaging – straight and bent, ordering of two extra cam dimensions possible.

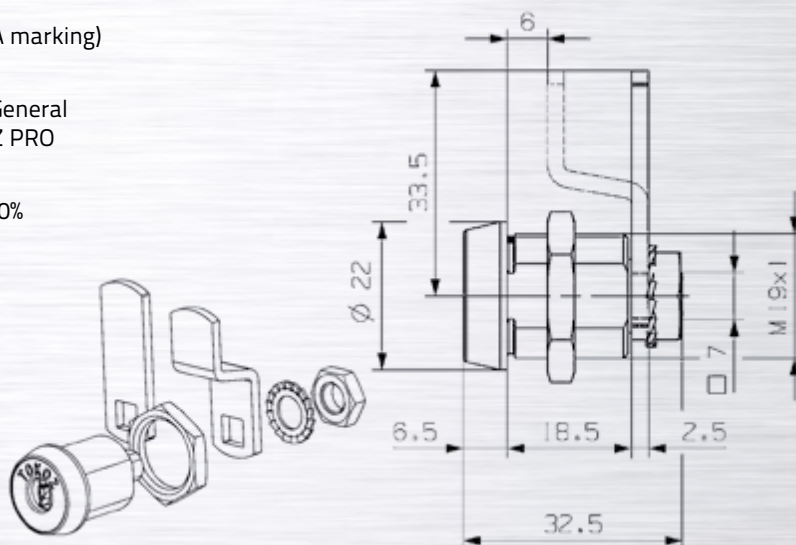

	Number of keys	Identification Card	Packaging	Quantity per package	Weight in kg
Cam Lock PRO	3	x	Open plastic box	1 pcs and 2 cam	0,13

# X SAFETY BOX

## STOP THE THIEVES

### Guarantees your peaceful sleep

X SAFETY BOX I and X SAFETY BOX II are intended for double or single doors and are replacing the traditional padlock combined with hasps or bars. It is an innovated version of TOKOZ bars. Their big asset is the simplicity of control. The door opens with one swift movement of the key and everything remains on the door. No padlock or other element impedes your hands. X SAFETY BOX III and X SAFETY BOX IV are anchoring systems to firm bases to secure free-standing objects.

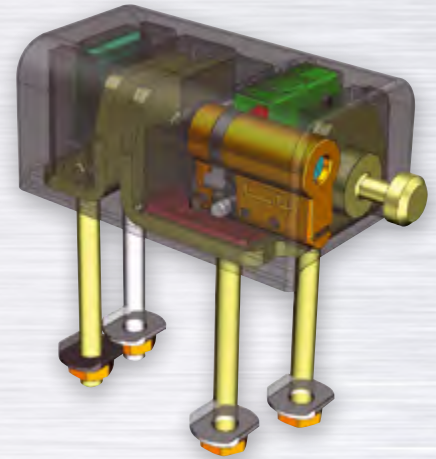

51121  
X SAFETY BOX I



3



- > easy to exchange single cylinders with dimension 27–33 (TOKOZ TECH, ASSA ABLOY, MUL-T-LOCK, EVVA, etc.), can also be delivered without the cylinders
- > possibility of integration with keyed alike, master keyed and general master keyed systems and interconnection with cylinders as well
- > standardly delivered with single cylinders that correspond with the safety level of the product itself
- > can be fasten to various places: screwed on wooden or metal doors or welded to metal surfaces
- > high security class due to covered pin
- > chrome-manganese steel pin, hardened and corrosion resistant (ion nitration) surface
- > massive cast zinc X SAFETY BOX I, II, III body is resistant to brute force and destruction

51122  
X SAFETY BOX II



3



- > base plates are from weldable steel with hardened surface, surface finish – zinc-blue chrome
- > X SAFETY BOX IV body is made of chromium manganese hardened steel resistant to extreme brute force
- > special anchors that make it impossible to wrench the base from the ground are part of packaging
- > X SAFETY BOX III also offers chains and cables of various sizes
- > for X SAFETY BOX IV, you need to make an additional purchase of a chain we are offering various sizes
- > delivered with three keys

X SAFETY BOX is protected as a Utility Model no. 18557





# X SAFETY BOX



51123  
X SAFETY BOX III

51143  
X SAFETY BOX IV

3

4



- X SAFETY BOX III without a chain – 51114
- X SAFETY BOX III  $\varnothing$  8mm, 1 m – 51123
- 2 m/ $\varnothing$  8mm hardened chain for X safety BOX III – 51191
- 3 m/ $\varnothing$  8mm hardened chain for X safety BOX III – 51192
- 5 m/ $\varnothing$  5mm cable for X SAFETY BOX III – 25930
- 10 m/ $\varnothing$  5mm cable for X Safety BOX III – 25931
- 15 m/ $\varnothing$  5mm cable for X SAFETY BOX III – 2593

- 1 m/ $\varnothing$  13mm hardened chain for X safety BOX IV – 25941
- 2 m/ $\varnothing$  13mm hardened chain for X safety BOX IV – 25942
- 3 m/ $\varnothing$  13mm hardened chain for X safety BOX IV – 25943

	X SAFETY BOX I	X SAFETY BOX II	X SAFETY BOX III	X SAFETY BOX IV
Zinc casting	x	x	x	
Steel				x
Resistance to corrosion	According to norm	According to norm	According to norm	According to norm
Number of keys	3	3	3	3
Identification Card	x	x	x	x
Packaging	Box	Box	Box	Box
Quantity per package	1	1	1	1
Weight in kg	2,70	1,80	4,10	3,00





# UZ PRO



## Unique products of TOKOZ brand!

Sets of bars and padlocks developed specifically to be used on garage doors, gates and similar entry points. Due to the construction the bars as well as the padlocks endure extreme climatic conditions. Superb value price ratio.



214311

UZ PRO 210



214412

UZ PRO 220



51611

UZ PRO 230



51811

UZ PRO 240



- > mechanical breaking of the lock impeded by the special design of the bar
- > lockable bars with 4 mm thick arms of steel plate resist sawing, drilling and wrenching, the bar is high resistance colour varnished
- > lockable bars are supplied with Extreme PRO padlock with rotating discs mechanism 100% resistant to bumping, lock picking and drilling, guarantees reliability in extreme climatic conditions
- > supplied with Extreme PRO padlock, offers the possibility to use the Keyed Alike systems (KA marking), Master Keyed and General Master Keyed (SGMK marking) system with TOKOZ PRO products
- > body of the security bar is made of steel pressing, 4 mm thick hardened steel plate, powder varnished
- > the bar is secured against wrenching with steel counterplates
- > packed with carriage bolts



# Key profiles

**TOKOZ PRO** system allows considerable number of key profiles. We currently offer three different key profiles. Each profile is indicated by a combination code. Available profiles are marked as T02, T03 and T04 separately for padlocks, cylinders and the Master Keyed and General Master Keyed system. The amount of profiles will be gradually increased according to customer needs

## Key marking

TOKOZ PRO system keys have the profile and the system number indicated on the key shank. The key shank of standard keys is stamped only with TOKOZ logo. System keys can be ordered only after presenting a certificate that comes with the system and after a confirmation from the system owner. Verification from the system owner serves for protection against unauthorized acquiring of the keys.

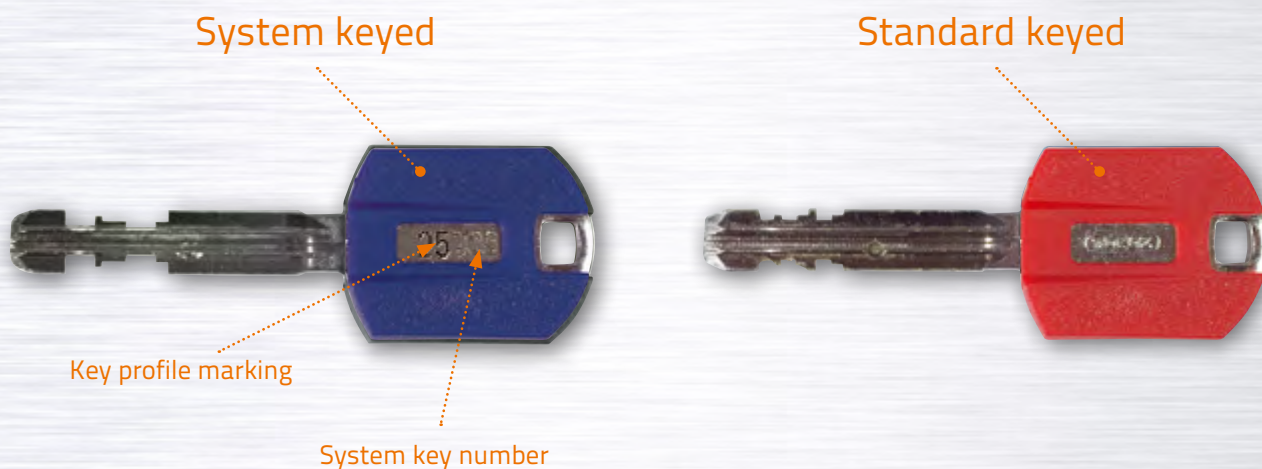

## Spare keys manufacturing

After submitting the security card and the original key, spare keys are made by contractual partners of TOKOZ. The security card is part of the TOKOZ product package. Contractual partners use original semi-finished TOKOZ keys for manufacturing.



# Modular cylinder

## Advantages of the modular cylinder

- > TOKOZ PRO cylinders are put together like modular systems.
- > Advantage of the modular system is that the length of the cylinder can be adjusted in the shop or directly in the place of assembly. It is a flexible solution that allows complying with the customer's wishes.
- > The length of the cylinder can be altered by 5 mm.
- > If a cylinder is assembled at the place of a customer, the cylinder can be fit to required length.
- > TOKOZ PRO modular set with components for construction of different types of cylinders.  
Purchase Order number: **22241**



Modular set TOKOZ PRO – parts list	Product number	Quantity/pcs
Modular pin	22245	30
Attachment 5 (size 5 mm)	22258	6
Attachment 10 (size 10 mm)	22259	4
Attachment 20 (size 20 mm)	22260	2
Carrier 5 (size 5 mm)	222611	6
Carrier 10 (size 10 mm)	222621	8
Switching bar PRO 5 (size 5 mm)	222610	6
Switching bar 10 (size 10 mm)	222622	8
Modular bar 1 – 54 mm	22264	2
Modular bar 2 – 64 mm	22265	2
Modular bar 3 – 74 mm	22266	2
Modular bar 4 – 84 mm	22267	2
Modular bar 5 – 94 mm	22268	2
Modular bar 6 – 74 mm	22269	2
Modular bar 7 – 84 mm	22270	2
Modular bar 8 – 94 mm	22271	2
Modular bar 9 – 94 mm	22272	2
Modular bar 10 – 104 mm	22273	2
Modular bar 11 – 114 mm	22274	2
Modular bar 31 – 154 mm	22298	2
Distance washer 0,3 mm	22242	20



# TOKOZ PRO Unification Set

TOKOZ PRO products are above all developed for easy modification within the system. Adjusting itself is very simple and fast.

TOKOZ PRO unification set comprises pins and components of all TOKOZ PRO products.

Purchase Order number: **22240**



Unification set TOKOZ PRO – parts list	Product number	Qty/pcs
Distance washer 0,3	22242	20
Ball, diam. 3,15	22243	10
Spring	22256	10
Spacer	22244	20
Barrier	222461	3
Pin diam. 1,2	22246	3
Disc 1 PRO	22247	20
Disc 2 PRO	22248	20
Disc 3 PRO	22249	20
Disc 4 PRO	22250	20
Stopper 1 PRO	222501	3
Keyhole plate new	222503	3
Keyhole plate old	222502	1
Controller subassembly T04	22251	5
Controller subassembly T02	22252	5
Coupling subassembly with adjustable cam	222544	3
Coupling with emergency element and adjustable cam	222543	2
Coupling	22255	3
Short loading key	22275	1
Long loading key	22276	1
Screwdriver PRO	222761	1

The offered set includes a list of cylinder pieces and instructional video describing how to manipulate TOKOZ PRO cylinder.

# TOKOZ TECH SYSTEM = TECHNICALLY SMART



CYLINDER CONSTRUCTION FOR TOKOZ TECH SYSTEM IS PROTECTED BY TWO PATENTS.

Patent CZ 305479

Patent CZ 305480

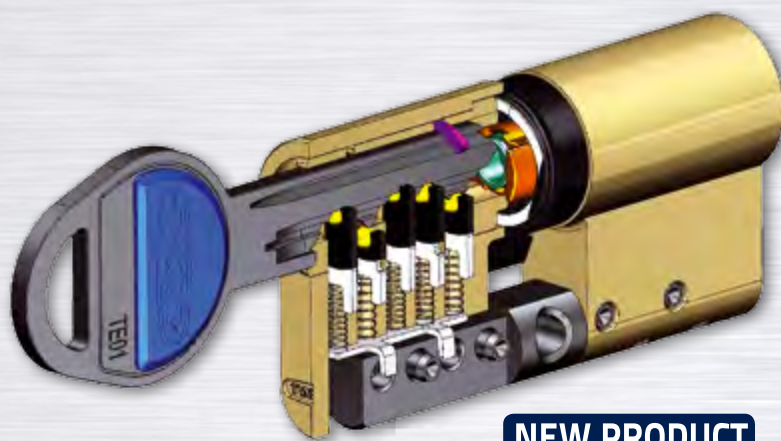

**NEW PRODUCT**

## TOKOZ TECH

Sometimes it only takes a fresh look at a functioning mechanism to create a new, technologically advanced product. This is the case with the **TOKOZ TECH** cylinder – even though it belongs into the broadest category of spring pin cylinders, with a couple of smart technical adjustments it eliminates design limitations and reaches new levels of security and reliability.

The breakthrough, patented solution, used only by the **TOKOZ TECH** cylinder within this category, are rolling element bearings fitted above pins.

The new element removes friction from within the mechanism enabling, in theory, zero wearing of the key and the pin itself. For the first time, the excessive key cutting wear, capable of obstructing a cylinder's function, is prevented which multiplies the system's lifetime. At the same time, the risk of poor key code copying upon duplication is reduced.

**TOKOZ TECH** is especially resistant to so called destructive and non-destructive break-in methods (lock picking – anti pick, bumping – anti bump, and the like). These attributes together with the inner mechanism pull out resistance place this type of cylinder and other products

with the **TOKOZ TECH** locking system into a higher security level. The TOKOZ TECH cylinder is certified in the RC 3 in accordance with EN 1627 and BT3 in accordance with EN 1303.

For user comfort, the cylinder is supplied in various design versions – single cylinder, double cylinder, cylinder with sprocket, cylinder with thumbturn, in X BOX hasps and anchoring systems, in the Konti lock for bins and containers, in the MOTO 50 system of padlock with chain or in PLUTO padlocks.

Resistance	<b>3</b>	Security class	Application		Master keyed system
		100% bumping resistance (anti-bump)			Outdoor conditions
		Maximum protection against drilling (anti-drill)			
		100% protection against lock picking (anti-pick)			
		Protection against snapping			



# TOKOZ TECH Cylinder

## Quality and long-lifetime

TOKOZ TECH cylinders belong on Czech and world markets to quality locking systems with long lifetime. They are suitable for daily use and places with high security requirements as entrance door of houses, flats and companies.



- > a security lock cylinder certified in compliance with EN 1303, EN 1627
- > a unique locking system based on flat pins with bearings
- > 100% resistance to lock picking and lock bumping
- > maximum protection against drilling
- > reliable even in extreme climatic conditions such as dust, freezing temperatures, water, grease
- > components of the locking mechanism made of stainless material
- > modular construction – easy assembly of various lengths
- > offers the possibility of the Keyed Alike systems integrated with TOKOZ TECH products
- > offers the possibility to use the Master Keyed and General Master Keyed systems with TOKOZ TECH products
- > compatible with all types of standard hardware
- > suitable for standard and atypical door thickness
- > surface finishing: satin-nickel body
- > all-metal key with colour caps in blue, black, red, orange, and grey colour
- > standardly supplied with three keys and an identification card

# TOKOZ TECH Cylinder

**TECH**



DOUBLE CYLINDER  
TOKOZ TECH



Item	Purchase Order number	Purchase Order number – product with emergency function	Cylinder size	Total length
TOKOZ TECH 30/30	54300	73500	30/30	60
TOKOZ TECH 30/35	54301	73501	30/35	65
TOKOZ TECH 30/40	54302	73502	30/40	70
TOKOZ TECH 30/45	54303	73503	30/45	75
TOKOZ TECH 30/50	54304	73504	30/50	80
TOKOZ TECH 30/55	54305	73505	30/55	85
TOKOZ TECH 35/35	54319	73519	35/35	70
TOKOZ TECH 35/40	54320	73520	35/40	75
TOKOZ TECH 35/45	54321	73521	35/45	80
TOKOZ TECH 35/50	54322	73522	35/50	85
TOKOZ TECH 35/55	54323	73523	35/55	90
TOKOZ TECH 40/40	54336	73536	40/40	80
TOKOZ TECH 40/45	54337	73537	40/45	85
TOKOZ TECH 40/50	54338	73538	40/50	90
TOKOZ TECH 40/55	54339	73539	40/55	95



DOUBLE CYLINDER TOKOZ TECH  
WITH THUMBTURN



Item	Purchase Order number	Cylinder size	Total length
TOKOZ TECH with thumbturn 30/30	54400	30/30	60
TOKOZ TECH with thumbturn 30/35	54401	30/35	65
TOKOZ TECH with thumbturn 30/40	54402	30/40	70
TOKOZ TECH with thumbturn 30/45	54403	30/45	75
TOKOZ TECH with thumbturn 30/50	54404	30/50	80
TOKOZ TECH with thumbturn 30/55	54405	30/55	85
TOKOZ TECH with thumbturn 35/35	54420	35/35	70
TOKOZ TECH with thumbturn 35/40	54421	35/40	75
TOKOZ TECH with thumbturn 35/45	54422	35/45	80
TOKOZ TECH with thumbturn 35/50	54423	35/50	85
TOKOZ TECH with thumbturn 35/55	54424	35/55	90
TOKOZ TECH with thumbturn 40/40	54439	40/40	80
TOKOZ TECH with thumbturn 40/45	54440	40/45	85
TOKOZ TECH with thumbturn 40/50	54441	40/50	90
TOKOZ TECH with thumbturn 40/55	54442	40/55	95
TOKOZ TECH with thumbturn 45/45	54457	45/45	90
TOKOZ TECH with thumbturn 45/50	54458	45/50	95

**Cylinder with thumbturn** – when ordering a thumbturn product, it is necessary to indicate with a letter “K” the cylinder side with thumbturn (e. g. TOKOZ TECH 30/K35).



Item	Purchase Order number	Cylinder size	Total length
TOKOZ TECH with sprocket 30/30	56100	30/30	60
TOKOZ TECH with sprocket 30/35	56101	30/35	65
TOKOZ TECH with sprocket 30/40	56102	30/40	70
TOKOZ TECH with sprocket 30/45	56103	30/45	75
TOKOZ TECH with sprocket 30/50	56104	30/50	80
TOKOZ TECH with sprocket 30/55	56105	30/55	85
TOKOZ TECH with sprocket 35/35	56119	35/35	70
TOKOZ TECH with sprocket 35/40	56120	35/40	75
TOKOZ TECH with sprocket 35/45	56121	35/45	80
TOKOZ TECH with sprocket 35/50	56122	35/50	85
TOKOZ TECH with sprocket 35/55	56123	35/55	90
TOKOZ TECH with sprocket 40/40	56136	40/40	80
TOKOZ TECH with sprocket 40/45	56137	40/45	85
TOKOZ TECH with sprocket 40/50	56138	40/50	90
TOKOZ TECH with sprocket 40/55	56139	40/55	95
TOKOZ TECH with sprocket 45/45	56151	45/45	90
TOKOZ TECH with sprocket 45/50	56152	45/50	95

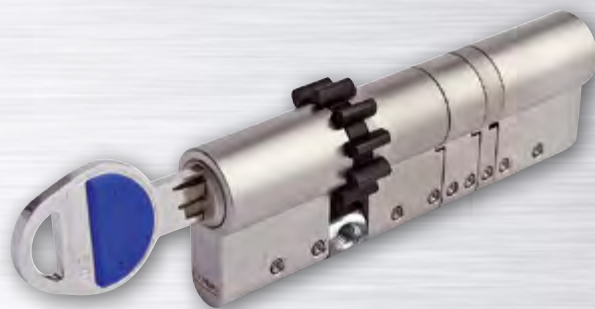

DOUBLE CYLINDER TOKOZ TECH WITH SPROCKET (10 TEETH)



Item	Purchase Order number	Cylinder size	Total length
Single TOKOZ TECH 30	73111	30	30
Single TOKOZ TECH 35	73112	35	35



SINGLE CYLINDER TOKOZ TECH



## ATTENTION NEW ITEM!

**Emergency function** – this function enables cylinder to be opened even in case of key being inserted from the other side.



Prostupová spojka  
Emergency function  
PACKAGE LABELING

**Adjustable cam** – starting 2016, this function is a standard in all TOKOZ TECH cylinders. It enables cam setting into one of twelve possible positions, each by 30°. Cam setting is done in manufacturing or by your locksmith. Standard setting is 30°.



Stavitelný zub  
Adjustable cam  
PACKAGE LABELING

# TOKOZ TECH with a thumbturn and a safety catch

## TOKOZ PRO with a thumbturn and a safety catch

The cylinder with a thumbturn knob and a safety catch is locked and unlocked just like any other lock of such type. The feature that adds an extra function is the securing bolt. Pulling the thumbturn knob until the securing bolt springs out from the slot in the thumbturn knob puts out of operation the part of the locking mechanism that is controlled by a key, which makes unlocking the door with a key impossible from outside.

In order to restore the key function, it is necessary to position the thumbturn knob vertically so that the securing bolt is pointed upwards and then push the bolt into the knob. The function is particularly useful against unwanted opening from the outside, for example at night.

We also offer the lock with a thumbturn in a variant without the safety catch.



Steel



Silver



Bronze



Black

You may choose the colour of the thumbturn from several variants offered.

**ATTENTION! Cylinders with thumbturn are generally not suitable for forging in and glass doors – safety reasons.**





# Konti TECH

## Securing containers and dustbins

KONTI TECH container lock can be integrated into the TOKOZ TECH system. Innovation of the current version of the KONTI lock brings increased security and possibility to connect to the standard Master Keyed and General Master Keyed systems. The lock can be used for both securing containers and dustbins, and as anchor system for free-standing objects or an additional lock for attic and basement areas.



57702

### KONTI TECH 9



- > provided with TOKOZ TECH safety locking system
- > offers the possibility of the Keyed Alike systems integrated with TOKOZ TECH products
- > offers the possibility to use the Master Keyed and General Master Keyed systems with TOKOZ TECH products
- > cylinder with high protection against drilling and 100% protection against lock picking and lock bumping



57701

### KONTI TECH 12



- > reliable in extreme climatic conditions
- > lock body made of zinc alloy is more resistant to forced attack
- > steel chain extremely resistant to wrenching, 9 or 12 chain links (adjustable according to requirements of the customer)
- > surface finishing: varnished body, galvanized chain
- > supplied with fasteners



	KONTI TECH 9	KONTI TECH 12
Quantity of the keys	2	2
Package of 1 piece/bulk	without package or skin/box	without package or skin/box
Number of pieces in a bulk package	10	10
Weight of bulk package in kg	8,9	9,1

# Pluto 50 TECH – Padlock

## The star among padlocks

Thanks to its size and superior quality is padlock Pluto 50 TECH ideal for both exteriors and interiors. Used together with czech chains, it belongs among the best security products for motorcycles, four-wheelers, and other vehicles.



29311  
PLUTO 50 TECH



29312  
PLUTO 50 TECH Long



### Pluto 50 TECH

- > cylinder with high protection against drilling and 100% protection against lock picking and lock bumping
- > reliable even in extreme climatic conditions (water, freezing temperatures, dust, grease)
- > possibility of integration with Keyed Alike, Master Keyed and General Master Keyed systems and inter-connection with cylinders as well
- > a solid zinc body resistant to forced attack and breaking
- > hardened shackle with improved resistance to cutting, sawing, prying
- > both-side-secured shackle revolves by 360° after unlocking

### MOTO 50

- > combination of padlock Pluto 50 TECH and Czech hardened steel chain
  - resistant to sawing and snip
- > chain – 1 m or 2 m
- > black textile sleeve protects locked objects against damage

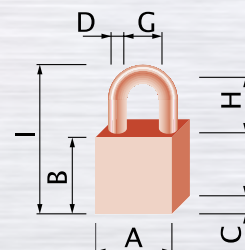





**29315** **NEW PRODUCT**  
MOTO 50 TECH/1000

**29316** **NEW PRODUCT**  
MOTO 50 TECH/2000



	Pluto 50 TECH	Pluto 50 TECH Long	MOTO 50 TECH/1000	MOTO 50 TECH/2000
Dimension A	53	53		
Dimension B	45	45		
Dimension C	30	30		
Dimension D	10	10		
Dimension G	20	20		
Dimension H	17	35		
Dimension I	72	90		
Zink Body	X	X	X	X
Hardened shackle	X	X	X	X
Chain			Ø 8mm/1 m	Ø 8mm/2 m
Resistance to corrosion	2 times higher than prescribed by the standard	2 times higher than prescribed by the standard	According to norm	According to norm
Number of keys	3	3	3	3
Identification card	X	X	X	X
Packaging	open plastic box/box	open plastic box/box	without package	without package
Weight in kg	0,50/3,15	0,45/3,03	1,80	2,50

# X SAFETY BOX – hasp and anchor system

## STOP THE THIEVES

### Guarantees your peaceful sleep

X SAFETY BOX I and X SAFETY BOX II are intended for double or single doors and are replacing the traditional padlock combined with hasps or bars. It is an innovated version of TOKOZ bars. Their big asset is the simplicity of control. The door opens with one swift movement of the key and everything remains on the door. No padlock or other element impedes your hands. X SAFETY BOX III is anchoring system to firm bases to secure free-standing objects.

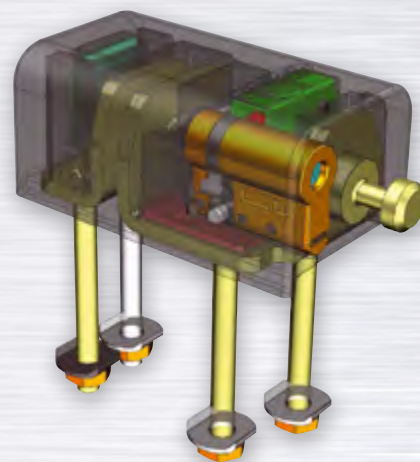

51131

X SAFETY BOX I



3



- > easy to exchange single cylinders with dimension 27–33 (TOKOZ PRO, ASSA ABLOY, MUL-T-LOCK, EVVA, etc.), can also be delivered without the cylinders
- > possibility of integration with Keyed Alike, Master Keyed and General Master Keyed and interconnection with cylinders as well
- > standardly delivered with single cylinders that correspond with the safety level of the product itself
- > can be fasten to various places: screwed on wooden or metal doors or welded to metal surfaces
- > high security class due to covered pin
- > chrome-manganese steel pin, hardened and corrosion resistant (ion nitration) surface

51132

X SAFETY BOX II



3



- > massive cast zinc X SAFETY BOX I, II, III body is resistant to brute force and destruction
- > base plates are from weldable steel with hardened surface (cementation), surface finish – zinc-blue chrome
- > special anchors that make it impossible to wrench the base from the ground are part of packaging
- > X SAFETY BOX III also offers chains and cables of various sizes
- > delivered with three keys

X SAFETY BOX is protected as a Utility Model no. 18557





# X SAFETY BOX TECH



51133  
X SAFETY BOX III



3



- X SAFETY BOX III without chain – 51114
- X SAFETY BOX III  $\phi$  8 mm, 1 m – 51123
- Chain X SAFETY BOX III  $\phi$  8 mm, 2 m – 51191
- Chain X SAFETY BOX III  $\phi$  8 mm, 3 m – 51192
- String X SAFETY BOX III  $\phi$  5 mm, 5 m – 25930
- String X SAFETY BOX III  $\phi$  5 mm, 10 m – 25931
- String X SAFETY BOX III  $\phi$  5 mm, 15 m – 25932

	X SAFETY BOX I	X SAFETY BOX II	X SAFETY BOX III
Zinc casting	x	x	x
Resistance to corrosion	According to norm	According to norm	According to norm
Number of keys	3	3	3
Identification Card	x	x	x
Packaging	Box	Box	Box
Quantity per package	1	1	1
Weight in kg	2,70	1,80	4,10

# Modular and Unification Set TOKOZ TECH

TOKOZ TECH products are specially designed not only for introduction into systems But thanks to the modular system is very easy to adjust the length of the liner as needed. The length of the cylinder can be altered by 5 mm. Advantages of the modular cylinder.

Purchase Order number – Unification Set TOKOZ TECH: **222401**

Purchase Order number – Modular Set TOKOZ TECH: **222411**



Unification set TOKOZ TECH – parts list	Product number	Qty/ pcs
Distance washer 0,3 mm	22242	10
Distance washer 0,2 mm	222420	10
Coupling subassembly with adjustable cam TECH	222542	3
Coupling subassembly with emergency element and adjustable cam TECH	222541	2
Spring TECH	222412	50
Spring cover TECH	222416	10
Ball diam. 2,38 TECH	222412	50
Pin 1 TECH	222421	40
Pin 2 TECH	222422	40
Pin 3 TECH	222423	40
Pin 4 TECH	222424	40
Pin 5 TECH	222425	40
Pin 6 TECH	222426	40
Pin 7 TECH	222427	40
Pin 8 TECH	222428	40
Blocking pin TECH (with cutting)	222415	20
Blocking pin TECH	222414	30
ROTOR TE01 TECH	222418	10
Cylinder body TECH	222419	10
Rotor stopper 3 TECH	222417	10
Sprocket 10 teeth	222531	2

Modular set TOKOZ TECH – parts list	Product number	Qty/ pcs
Modular pin	22245	30
Attachment 5 (5 mm)	22258	6
Attachment 10 (10 mm)	22259	4
Attachment 20 (20 mm)	22260	2
Carrier 5	222611	6
Carrier 10	222621	8
Switching bar 5 TECH	222612	6
Switching bar 10	222622	8
Modular bar 1 TECH	222641	2
Modular bar 2 TECH	222651	2
Modular bar 3 TECH	222661	2
Modular bar 4 TECH	222671	2
Modular bar 5 TECH	222681	2
Modular bar 6 TECH	222691	2
Modular bar 7 TECH	222701	2
Modular bar 8 TECH	222711	2
Modular bar 9 TECH	222721	2
Modular bar 10 TECH	222731	2
Modular bar 11 TECH	222741	2
Modular bar 31 TECH	222981	2
Distance washer 0,3 mm	22242	10
Distance washer 0,2 mm	222420	10

The offered set includes a list of cylinder pieces and instructional video describing how to manipulate TOKOZ TECH cylinder.



# System Order Form

 <p>Santiniho 20/26 591 02 Zdar nad Sazavou tel: +420 724 632 643 e-mail: <a href="mailto:sg1h@tokoz.cz">sg1h@tokoz.cz</a></p>		System number:  System Name:		KEYS		No.:	1	2	3	4	5	6	7	8	9	10	11	12	13	14	15	16	17	18	19	20
Customer:	Registration No.:	Street:	Town/City:			Post Code:	Authorized person:	Phone:	E-mail:																	
NUMBER	DOOR NUMBER	DESCRIPTION	LOCATION (building)	LOCK TYPE	QUANTITY																					
1																										
2																										
3																										
4																										
5																										
6																										
7																										
8																										
9																										
10																										
11																										
12																										
13																										
14																										
15																										
16																										
17																										
18																										
19																										
20																										
21																										
22																										
23																										
24																										
25																										

# BK 300 – Security stainless steel fitting



An important novelty between security products is the stainless steel fitting. It forms, together with a TOKOZ cylinder, a highly resistant set suitable to extreme environments of industrial buildings, companies or, for example, remote locations where high security is needed.



State before assembly

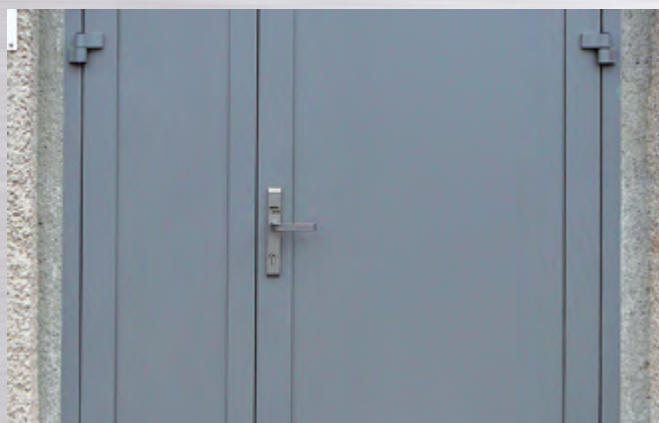

State after assembly

**NEW PRODUCT**



3



- > certified in accordance with EN 1627 and EN 1906, security class 3
- > shields, knob and handles made of austenitic stainless steel
- > parts manufactured on conventional machine tools, handle and knob bent from semi-finished machined parts
- > suitable for door thickness 40–80 mm (fixing screws and square spindle need shortening for door thinner than 75 mm)
- > distances 92, 90 and 72 mm
- > the length of the shield 266 mm, width 34 mm shield
- > choice of a combination of two different handles and knobs
- > lock cylinder not covered
- > the option to make customer logo on shield



# Notes

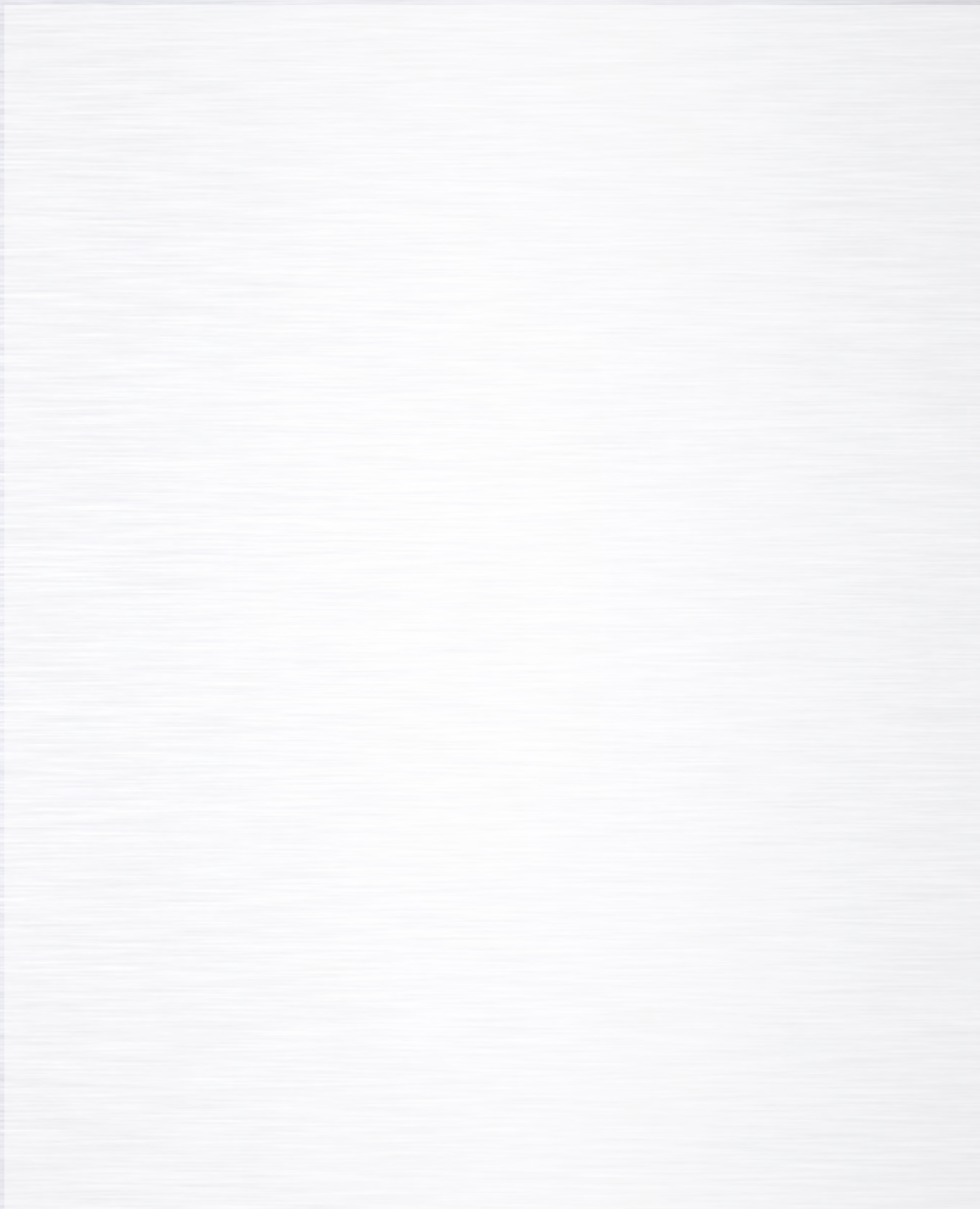

# TOKOZ PRO KEYED ALIKE, GENERAL AND MASTER KEYED SYSTEMS

## TOKOZ PRO

## SECURE AS A SAFEBOX

### 3

### 4

Security certified product line with unique locking system based on revolting retoting discs

> products in resistance class 3 and 4

We guarantee extraordinary resistance to all traditional types of the break-in:

- > 100% resistant to lock picking and hook picking
- > 100% resistant to bumping
- > 100% resistant to traditional drilling
- > high resistant to snapping
- > high outdoor resistance (dust, frost, water, grease)
- > modularity
- > General and Master Keyed systems

- 1 – TOKOZ PRO 400
- 2 – TOKOZ PRO 300
- 3 – Security stainless steel fitting BK 300
- 4 – UZ PRO 240
- 5 – KONTI PRO
- 6 – GAMA 60
- 7 – XSAFETY BOX IV
- 8 – EXTREME PRO
- 9 – Cam Lock PRO





# TOKOZ TECH KEYED ALIKE, GENERAL AND MASTER KEYED SYSTEMS

## TOKOZ **TECH** = TECHNICALLY SMART

### 3

Security certified lock cylinder with unique locking system based on flat pins with bearings

- > products in resistance class 3
- > high resistant to lock picking and hook picking
- > high resistant to bumping
- > high resistant to traditional drilling
- > long lifespan
- > hardened stainless pins
- > modularity
- > General and Master Keyed systems

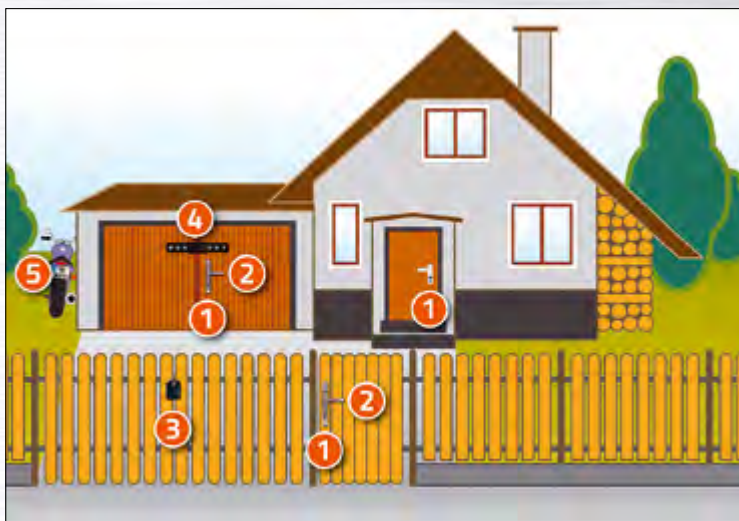

- 1 – TOKOZ TECH and TOKOZ TECH 300 with thumbturn
- 2 – Security stainless steel fitting BK 300
- 3 – Pluto TECH
- 4 – X SAFETY BOX TECH I
- 5 – MOTO 50/2000 TECH

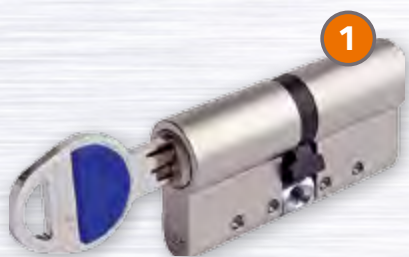

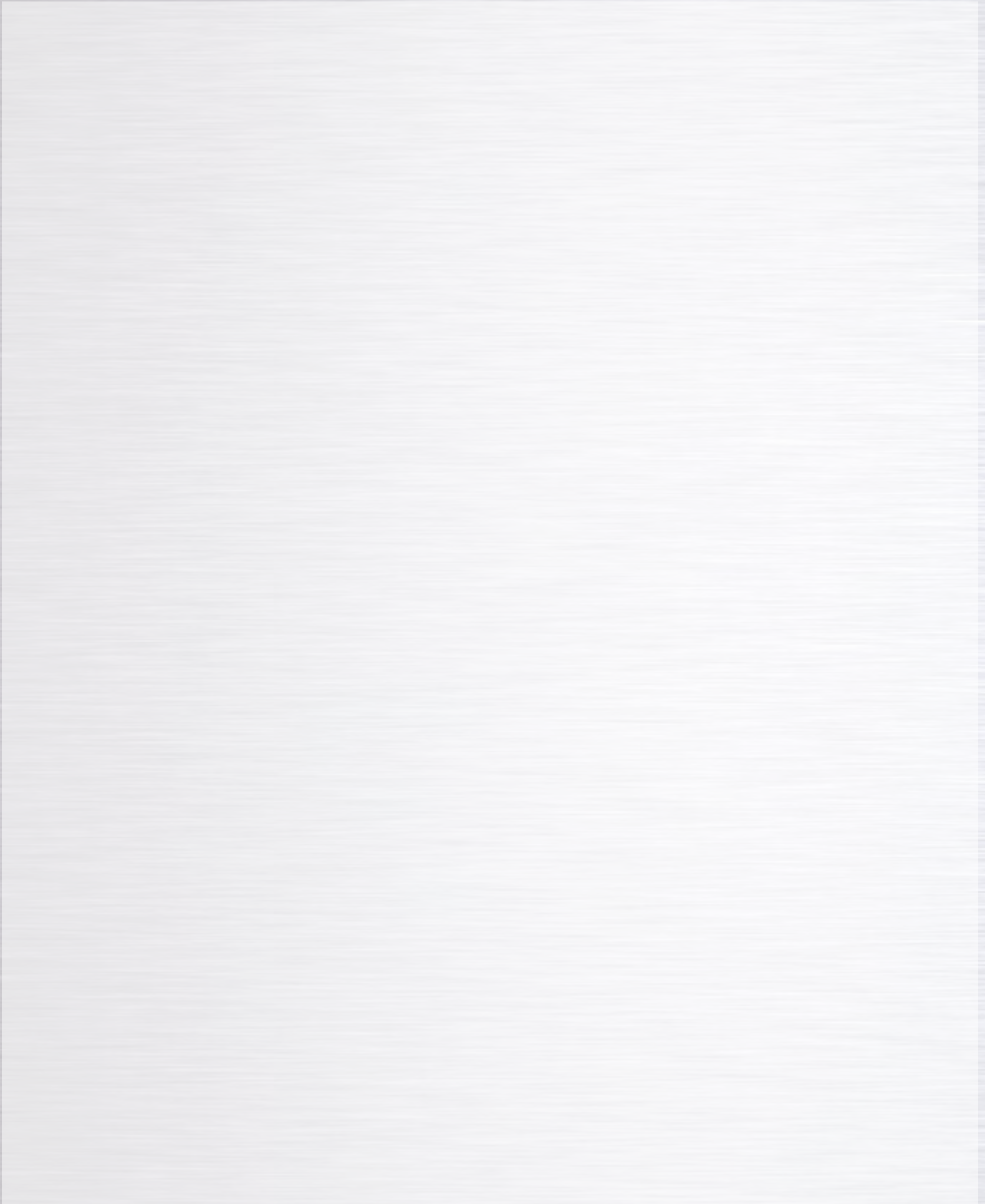





## SECURITY MECHANISM

We have diversified our permanent assortment and added security mechanisms and accessories. Therefore, the products that you can find in our current offer involve not only time-proven and still irreplaceable TOKOZ products but also new mechanisms that have been adapted to present-day security needs, plus they provide specific solutions.



## PADLOCKS

Within our range of products, we offer not only stars which have been on the market for decades, but also new, modern products fitting the present day exacting security demands. Vast majority of our products may be keyed alike, which brings further advantages in the form of lower number of keys needed to secure your property.



## BUILDING FITTINGS

The building fittings offer is focused on fittings for double paned wooden windows, which are still used in some of the houses or recreational buildings. Other products include special features for fittings, which not only enhance the window comfort when being operated, but may also serve as security measures.



## FURNITURE FITTINGS

In Furniture fittings, we still offer the typical TOKOZ products. Alongside the basic components, such as connecting fittings, various hangers, small hooks or magnetic catches, there are even specialties increasing the utility value of furniture.

### CERTIFIED SYSTEM OF QUALITY CONTROL



ISO/TS 16949:2009  
ISO 9001:2008  
ISO 14001  
ČSN OHSAS 18001  
Solvency certificate

---

# SECURE YOUR WORLD

---

**TOKOZ a.s.**  
Santiniho 20/26  
59102 Žďár nad Sázavou  
Czech Republic

tel. +420 566 802 111  
fax. +420 566 802 372  
e-mail: [mbox@tokoz.cz](mailto:mbox@tokoz.cz)

[WWW.TOKOZ.CZ](http://WWW.TOKOZ.CZ)

**TOKOZ®**